

WICONA[®]
TECHNIK FÜR IDEEN



A more fitting entrance

» WICSTYLE

ALUMINIUM DOORS

» WICSTYLE

A more fitting entrance

Why WICONA? Because WICONA has more than 60 years' experience as a successful aluminium systems company in Germany – and you can benefit from this on a daily basis. With us, not only do you have a reliable and collaborative supplier, but you also enjoy the benefits of a strong brand with a

high level of technological capability and sustainable success in the market. At WICONA, every detail counts: from the meticulous planning of the perfect material to be processed and fast delivery to the proactive sales support. That's why WICONA!



“First impressions count.” For a building, it is the entrance door that creates the impact. WICSTYLE doors from WICONA welcome visitors and users of cultural centres, health clubs, sports and educational facilities, office buildings and many other types of building – offering style and functionality.

Whether new build or renovation, WICONA has a proud history for developing a wide range of doors to fit a number of applications.



WICSTYLE Applications	4
Single-action doors	8
Circumferential leaf or base profile	10
Doors for high-traffic areas	12
Finger protection	14
Front doors	16
Panel doors	18
Indoor solutions	20
Swing doors	22
Swing doors / Swing doors with finger protection	24
Security doors	26
Burglar resistance	28
Bullet resistance	30
Fire protection	32
Smoke protection	34
Automatic doors	36
Thermally insulated automatic sliding doors	38

» Applications

The decisive criteria

The entrance door is an essential element of every building. No other building component has to simultaneously satisfy so many different requirements. Whether large entrance areas of administrative buildings or hotels, fire protection doors in hospitals, emergency exit doors in schools, access doors for commercial or industrial buildings, elegant front door systems for villas or automatic sliding doors: With WICSTYLE aluminium doors, a tailor-made solution can be achieved for every configuration. Thanks to its modular construction, the range offers versions which are technically perfect and visually harmonious for all types of application.

Security of people and property:

The burglar-resistant versions meet Class RC3 requirements, and the bullet-resistant versions meet those of Class FB4. Depending on the configuration, the fire protection solutions provide fire protection of up to 90 minutes. For schools and nurseries, a finger protection solution is available.

Easy to use and access:

The thermal insulation value is up to $U_d < 0.8 \text{ W}/(\text{m}^2\text{K})$, so it can be used in Passivhaus construction. The sound insulation value is up to 43 dB. The WICSTYLE range also includes accessible solutions and can be enhanced with access-control and drive systems.

Design and appearance:

WICSTYLE doors are available in a variety of numerous attractive designs and with leaf dimensions of up to 3.00 metres high. Fittings come in a choice of surface finishes – either lacquered or in a high-quality stainless steel version. The concealed hinges also ensure a coherent and harmonious appearance.

Streamlined manufacture and safe performance:

The entire manufacturing process can be done with a machining centre or with the WICONA multi-stamp concept. The unique range of locks and fittings enables ultra-fast installation. The innovative sealing system ensures the best impermeability. The CE-marking is valid for all applications, and certificates with 1 million test cycles are available for a range of configurations.

WICSTYLE – at a glance



All elements have been tested and approved for their application by our development team. So you can rely on the guaranteed scope of performance of WICSTYLE doors.



Burglar- and bullet resistance



Streamlined manufacturing process



Availability of all configurations



Top performance

	WICSTYLE 65 evo / 75 evo	WICSTYLE 65	WICSTYLE 77 FP	WICSTYLE 65 N	WICSTYLE 65 ED
Security of people and property					
Burglar resistance	RC3	–	RC2	WK2	–
Bullet resistance	FB4	–	–	–	–
Fire protection / Smoke protection (RS)	–	–	•	•	–
Escape routes EN 179 / EN 1125	•	–	•	•	•
Finger protection	•	•	–	•	•
Performance values construction physics and user-friendliness					
Thermal insulation W/(m²K)	1,6 bei U _g 1,1	1,7 bei U _g 1,1	2,0 bei U _g 1,1	–	1,5
Soundproofing (dB)	43	43	–	–	–
Accessibility	•	•	•	•	•
Operating forces	Class 2	Class 2	Class 2	–	–
Test cycles	500.000	1.000.000	200.000		1.000.000
Design and appearance					
Panel	•	–	•	–	–
Concealed hinges	•	•	–	•	–
Maximum dimensions/Leaf W x H	1.400 x 2.520	1.500 x 2.600	1.500 x 3.000	1.400 x 2.826	2.000 x 3.000
Top performance					
Air permeability	Class 4	Class 4	Class 4	–	Class 2
Driving rain resistance	Class 7A	Class 7A	Class 6A	–	Class 5A
Ability to withstand wind load	Class C2	Class C2	Class C3 / B3	–	Class B1
Infill thickness (mm)	50 / 60	50	49	50 / 34	27
Weight per leaf (kg)	400	150	260	200	150
Types of opening					
Outward opening	•	•	•	•	–
Inward opening	•	•	•	•	–
Finger protection version	•	•	–	•	•
Swing door version	–	•	–	•	–
Sliding door	(•)	(•)	–	(•)	•
Manufacturing process					
Fitting of surface-mounted locks	•	•	•	–	–
Circumferential leaf	•	•	•	•	–
Leaf with base	•	–	•	•	–
Screw-on strips	•	•	•	–	–
Rolled strips	•	•	•	–	–
Concealed hinges	•	•	–	–	–
Stainless steel strips	•	•	•	•	–

» Guaranteed performance

Certified, high-quality equipment

Each building is unique. And each door must fulfil quite different user requirements. WICSTYLE doors from WICONA have been developed precisely for this performance profile. A high degree of flexibility in the equipment enables the door to be optimally adjusted for each construction situation.

Handles, strips and locks: All functional components are an integral part of the WICSTYLE product range. All elements are developed and tested in order to meet WICONA's high performance and quality standards.

Besides the fittings for the basic lacquered WICSTYLE range, WICONA can also supply a range of ultra-modern handles made of stainless steel for high-quality surface finishes, which match the design of the stainless steel strips.

For special security requirements, WICSTYLE aluminium doors can be fitted with emergency opening and emergency locking systems, as well as burglar-resistant and bullet-resistant elements, which comply with all applicable standards.



- 1- and 3-point locks
- electric opener
- integrated or surface-mounted door closure
- Panic function

Flexibility is the greatest asset: an overview of the high-performance strip system for WICSTYLE doors

- Adjustable 2- and 3-part rolled strips
- Adjustable 2- and 3-part screw-on strips
- Concealed hinges
- 3-part stainless steel strips
- Swing door fittings



concealed strip,
250 kg per leaf



adjustable 3-part stainless
steel strip, 200 kg per leaf



adjustable 3-part strip,
150 kg per leaf

Typical WICONA: innovation with efficiency

Energy efficiency is a key focus for WICSTYLE doors: the WICONA rolled strips permit complete thermal separation of the internal and external areas. Even the lock contributes to this, with its insulating plastic adapter.

Streamlined manufacturing

WICSTYLE evo is synonymous with maximum efficiency, process safety and reliable results. Many years of practical experience form the basis of this high standard.

Your advantage as an installer:
Innovative technology with high effectiveness in practice due to the following features:

- Simple logistics and reduced inventory through the use of common components (WICONA Unisys)
- Simple planning, ordering and amendments to orders right up to shortly before installation
- High levels of process safety as a result of common fabrication steps
- Short production times due to streamlined procedures

These competitive advantages have not happened by chance: We develop, test and deliver all the tools and accessories for the construction in accordance with the highest quality standards that you would expect from WICONA.

In detail, this means:

- Efficient and durable WICONA multi-stamp concept for each range, including instructions for use in accordance with health and safety regulations
- High-quality, reliable and customised small tools
- Proven maintenance products, which make your installation accessories a long-term investment

We have worked with our partners to understand their fabrication process and provide the necessary tools

The equipment supplied proposed by WICONA for each respective workshop is the result of this joint initiative, the practical experience of our partners and the know-how of our suppliers.

The benefits are obvious: reductions in costs, shorter production times and completely controllable manufacturing processes.

Prerequisites for guaranteed top performance in all areas are an optimally equipped workshop and the highest process efficiency.



» Single-action doors

The perfectly designed WICSTYLE single-action doors enable configurations for a wide range of application. They are modular in their design and satisfy the most diverse aesthetic and functional requirements.

As such, you can create a lasting first impression with individual WICSTYLE door construction, irrespective of the type of

building. The design details of the equipment are numerous: Single- or double-leaf, inward or outward opening, finger protection, panic function, fire protection and more...



Harmonious appearance: WICSTYLE single-action doors and WICLINE windows are a perfect match and can be integrated into WICTEC façades.



» Single-action door with circumferential leaf or base WICSTYLE 65 evo / 75 evo

Peak technical values for thermal insulation, high stability and the broad spectrum of applications make the WICSTYLE evo the ideal solution for all requirements of modern architecture for both new-builds and renovation projects. Due to their high load-bearing capacity and their functionality, WICSTYLE evo aluminium doors are frequently installed in high-traffic public buildings. They are available in profile depths of 65 mm and 75 mm, single- or double-leaf version, inwards or outwards opening and with automation options.

Thanks to their low-profile threshold, whose robustness has been tested at WICONA in a specially designed test bench, the doors meet the requirements for accessible buildings.

WICSTYLE evo doors are also suitable for emergency exits with the correct adaptations.

High energy efficiency is a characteristic: thermal insulation values to Passivhaus standards can be achieved. WICSTYLE evo is the first door on the market with full thermal separation in the lock area.

They are suitable for large dimensions and are designed for heavy infills, particularly for triple and soundproof glazing, and glazing with protective functions.



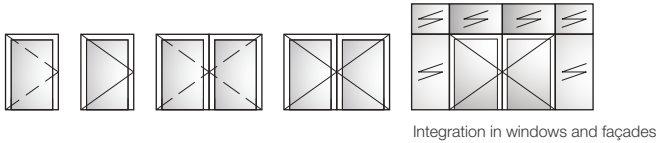

All configurations of the WICSTYLE 65 evo / 75 evo aluminium door range can be combined with other WICONA ranges. They can be fully integrated into WICTEC façade systems and WICLINE window systems: connection profiles, cover strips, seals, corners and other basic components are identical. Besides the visual consistency, the WICONA Unisys principle also enables you to streamline inventories and manufacturing times – a real bonus in terms of profitability. The design with circumferential leaves allows waste to be reduced to a minimum.

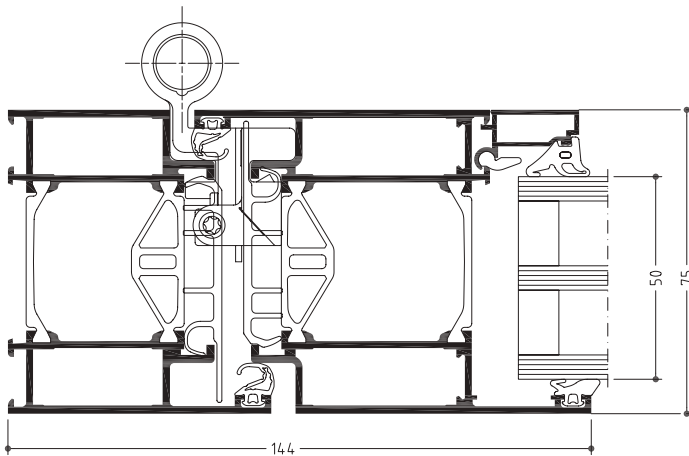

WICSTYLE 75 evo - Single-action door

Test results for product standard DIN EN 14351-1

Air permeability:	Up to Class 4
Driving rain resistance:	Up to 7A
Ability to withstand wind load:	Class C2
Soundproofing:	$R_w(C; C_{tr}) = 43 (-2; -5)$ dB
Operating forces:	Class 2
Load capacity of safety devices:	passed
Mechanical strength:	Class 3
Continuous operation:	Class 7 500,000 cycles
Impact resistance:	Class 1
Burglar resistance:	Class RC1N, RC2N, RC2, RC3
Bullet resistance:	Class FB4 NS

Technical capabilities

Section technology:

- Highly thermally insulated multi-chamber system with symmetrical structure for single- or double-leaf single-action door
- Inwards or outwards opening
- Infill thicknesses: 3 mm to 60 mm
- Different threshold profiles with or without thermal separation, accessibility for people with limited mobility
- Fixed, or combined with WICLINE evo windows for opening fanlights and side panels
- Thermal insulation: U_d -Values up to 0.8 W/(m²K)

Fittings:

- Screw-on strips
- Rolled strips
- concealed hinges
- Maximum dimensions: W 1,400 mm x H 2,520 mm
- Maximum weight for one leaf: up to 200 kg; for bullet resistance with additional strips, up to 400 kg

Additional versions:

- Swing door
- Panic function
- Burglar resistance Classes RC1N to RC3
- Bullet resistance Class FB4

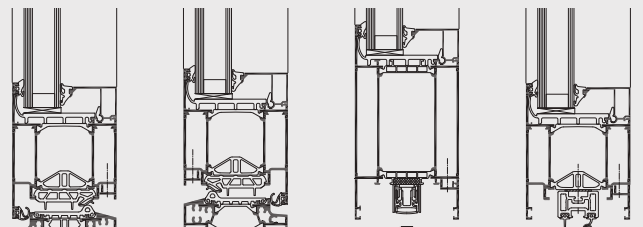

» Single-action doors for high-traffic areas WICSTYLE 65

Entrances to administrative buildings or shopping centres are high-traffic areas, meaning doors must be able to withstand high loads. WICSTYLE 65 evo doors meet these requirements, ensuring a long service life with excellent value for money.

The design ideas and the variety of WICSTYLE 65 evo versions enable them to also be used in apartment buildings with their high-intensity usage.

These variants are manufactured with reinforced profiles to allow for larger dimensions. The single-leaf version thus equates to a double doorway. WICSTYLE aluminium doors designed for high-traffic areas can be fitted with 3-part strips so are extremely durable and easy to use.

This version offers a Class 8 service life and has successfully undergone durability tests with 1,000,000 cycles.



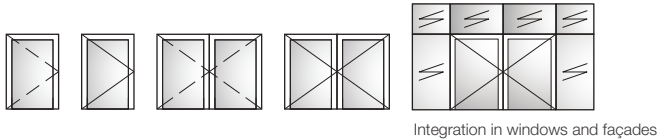

The version for high-traffic areas is based on the successful concept of the WICSTYLE evo doors and, with a 65 mm profile, is fully compatible with other solutions for ease of fabrication. The equipment and tools for manufacture remain the same.

The WICTYLE 65 door for high-traffic areas is also fully compatible with WICTEC façade systems and WICLINE window systems.

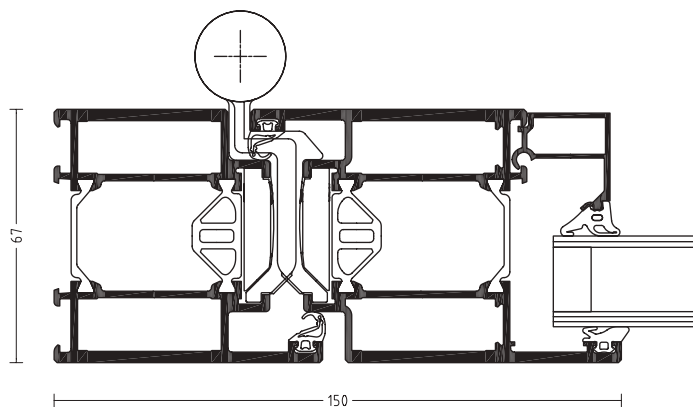

WICSTYLE 65 – version for high-traffic areas

Test results for product standard NF EN 14351-1

Air permeability:	Class 4
Driving rain resistance:	Class 7A
Ability to withstand wind load:	Class C2
Soundproofing:	$R_w (C; C_{tr}) = 43 (-2; -5) \text{ dB}$
Impact resistance:	Class 3
Mechanical strength:	Class 3
Continuous operation:	Class 8 1,000,000 cycles
Load capacity of safety devices:	passed
Operating forces:	Class 2

Technical capabilities

Section technology:

- Reinforced, thermally insulated multi-chamber system
- Inwards or outwards opening
- Single- or double-leaf
- Infill thicknesses: 3 mm to 50 mm
- Tight, accessible threshold
- Locks on PVC supports

Thermal insulation:

- $U_d = 1.7 \text{ W/(m}^2\text{K)}$ with $U_g = 1.1 \text{ W/(m}^2\text{K)}$

Fittings:

- Rolled strip:
 - Maximum weight 2 strips: 130 kg
 - Maximum weight 3 strips: 150 kg
- Maximum dimensions: W 1,500 mm x H 2,600 mm

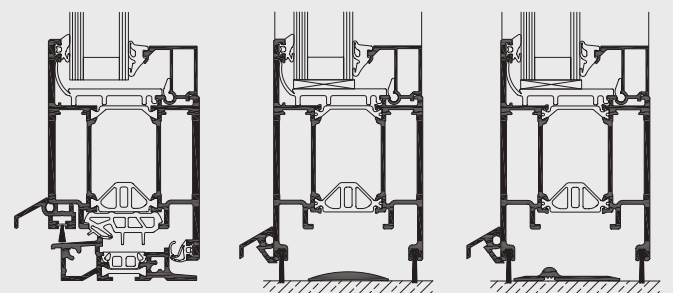

» Single-action doors with finger protection WICSTYLE 65 evo / 75 evo

In schools, nurseries and hospitals, there is a high risk that fingers could become trapped in doors.

The finger protection variation of the WICSTYLE evo aluminium door was specifically designed to avoid this potential hazard.

For this, a technical concept is used, which eliminates all possibility of getting fingers trapped between the frame and the leaf: irrespective of the position of both profiles, the contact points leave sufficient room for fingers. The space is fitted with a specially developed double seal which acts a barrier, in order to ensure perfect functionality and safety.



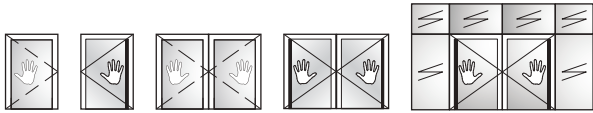

Integration in windows and façades



The finger protection variation is based on the technical concept of the WICSTYLE evo aluminium door and, with a 65 mm and 75 mm profile, is fully compatible with other solutions for ease of fabrication. The equipment and tools for manufacture remain the same, so that inventory does not increase unnecessarily and no time whatsoever is lost during production.

Finger protection is achieved using special seals and requires no additional elements for installation. Tools and manufacturing processes remain the same. As with all the versions in the WICSTYLE range, the door with an installation profile can be incorporated into the WICTEC façade and is also compatible with the WICLINE window system.

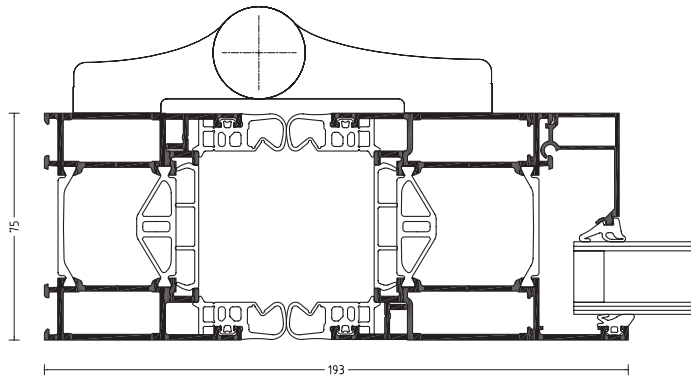

WICSTYLE 75 evo – Finger protection version

Technical capabilities

Section technology:

- Finger protection on hinged side using special seal, no additional components required.
- Meets the DIN 18650 Standard (Space > 25 mm)
- Highly thermally insulated multi-chamber system with symmetrical structure
- For single- or double-leaf single-action doors
- Inwards or outwards opening
- Infill thickness, glazing or panels: 6 mm to 60 mm
- Different threshold profiles with or without thermal separation, accessibility for people with limited mobility
- Fixed, or combined with WICLINE 65/75 evo windows for opening fanlights and side panels

Fittings:

- Screw-on strip
- Maximum dimensions of leaves: 1,400 mm x 2,520 mm
- Maximum weight of leaf: up to 200 kg

Additional versions:

- Installation in WICTEC façade with insertion frames

Test results for product standard DIN EN 14351-1

Air permeability:	Class 2
Driving rain resistance:	Class 6A
Ability to withstand wind load:	Class C2
Impact resistance:	Class 1
Mechanical strength:	Class 3
Continuous operation:	Class 7 500,000 cycles
Operating forces:	Class 2



» Front doors WICSTYLE 75 evo

Doors have many functions. They offer protection, both against unwanted guests and against environmental impact. They grant admission and should therefore be welcoming and integrate harmoniously into the building envelope.

With WICONA front doors, you can achieve individual, tailor-made solutions for high-quality front doors that deliver on functionality and appearance. No matter whether the developer requires the highest levels of security with bullet-resistance or wants a timeless entrance door that emphasises the individual character of his building.

This showcases the numerous benefits of aluminium – an attractive surface finish, high-tech designer handles, combinations with fanlights and side glazing, infills with glass elements in a wide variety of designs or panels, covering the leaves on both sides or with other kinds of infill: WICSTYLE doors satisfy the highest aesthetic demands.



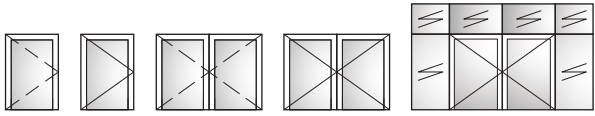

Integration in windows and façades

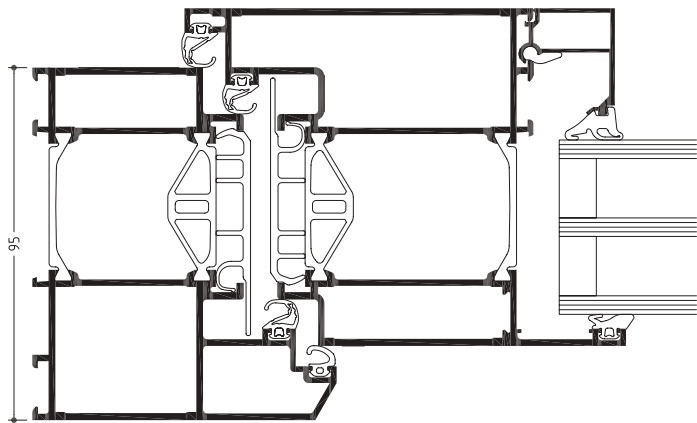

WICSTYLE 75 evo – Classic Design

Technical capabilities

Section technology:

- Highly thermally insulated multi-chamber system with symmetrical structure for single- or double-leaf single-action door
- Inwards or outwards opening
- Infill thicknesses: 3 mm to 60 mm
- Different threshold profiles with or without thermal separation, accessibility for people with limited mobility
- Fixed, or combined with WICLINE evo windows for opening fanlights and side panels
- Thermal insulation: U_d -Values up to 0.8 W/(m²K)

Fittings:

- Screw-on strips
- Rolled strips
- Concealed hinges
- Maximum dimensions: W 1,400 mm x H 2,520 mm
- Maximum weight for one leaf: up to 200 kg; for bullet resistance with additional strips, up to 400 kg

Test results for product standard DIN EN 14351-1

Air permeability:	Up to Class 4
Driving rain resistance:	Up to 7A
Ability to withstand wind load:	Class C2
Soundproofing:	$R_w(C; C_{tr}) = 43 (-2; -5) \text{ dB}$
Operating forces:	Class 2
Load capacity of safety devices:	passed
Mechanical strength:	Class 3
Continuous operation:	Class 7 500,000 cycles
Impact resistance:	Class 1
Burglar resistance:	Class RC1N, RC2N, RC2, RC3
Bullet resistance:	Class FB4

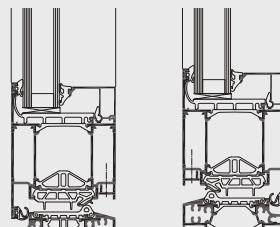

» Panel doors WICSTYLE 75 evo

Innovative door technology, offering comfort and design.

Complete system for single- and double-leaf doors, which can be both inward or outward opening. With its smooth rebated cover profile, it doesn't just deliver on looks, but its seamless design offers an easy cleaning solution.

Besides giving the leaf covering the desired visually harmonious effect, this construction also reduces deformation of the doors leaves to a minimum using the bi-metal effect.

Groundbreaking comfort thanks to E-Motion: this generation of motorised locks can be operated by remote keys, finger scan, smartphone or transponder, as well as via external access control systems.



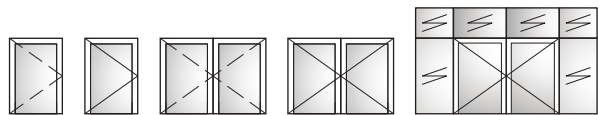

Integration in windows and façades

Characteristic design using profile covering infills. With this patented solution, WICONA introduces an innovative front door to meet the highest demands of design and energy efficiency.

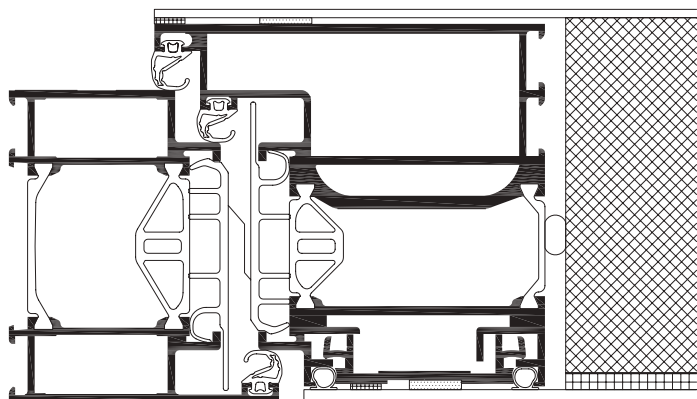

WICSTYLE 75 evo – Single-action door with double-sided leaf covering infill

Test results for product standard DIN EN 14351-1

Air permeability:	Class 3
Driving rain resistance:	Class 6A
Ability to withstand wind load:	Class C2
Operating forces:	Class 5
Climate effects:	Class 3(e)

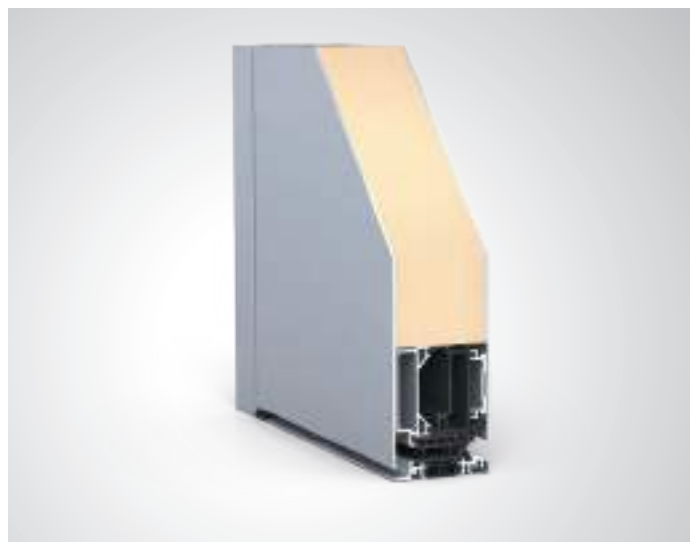

Technical capabilities

Section technology:

- Leaf profile 75 mm
- Frame profile 95 mm Classic Design or 75 mm flush-mounted
- Single-sided profile covering (or leaf covering)
- Double-sided profile covering
- Single-leaf, inward or outward opening
- Double-leaf, inward or outward opening

Thermal insulation:

- U_d-Values up to 0.78 W/(m²K)

Fittings:

- Concealed hinges, WICONA invisio system
- Max. leaf weight 160 kg
- Max. leaf format (W x H): 1,400 mm x 2,520 mm
- Automatically locking WICONA autotronic 834P motorised lock
- Finger scan and remote control (further options available)
- Integrated concealed door drive system

» Indoor solutions WICSTYLE 50/65 N

With WICSTYLE, you can satisfy your clients' wishes and expectations with a bespoke solution. For specific applications, there are a range of doors in our product offering with technical properties and design details which are tailored exactly to the area of application.

Quality, variety, security: The WICSTYLE and WICSTYLE evo range ensures these can be delivered by the individual and tailor-made requirements of the client.

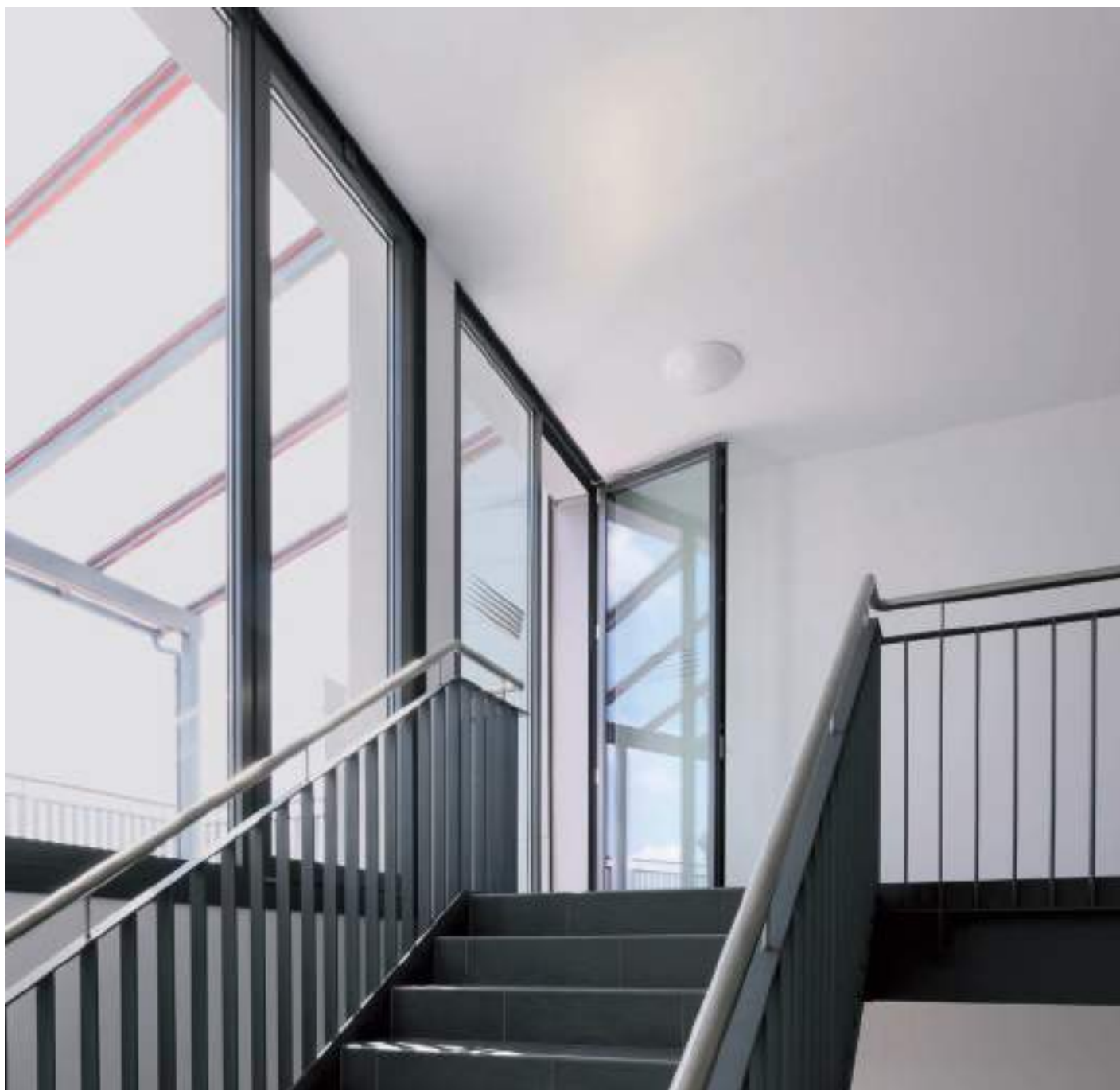

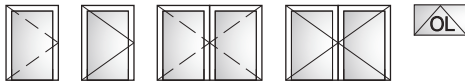

Integration in windows and façades

WICSTYLE 50/65 N are specifically designed for applications inside buildings or for when there are no requirements for thermal insulation. When factors such as functionality, durability and comfort come into focus, these non-insulated doors are the right choice.

They are fully compatible with WICTEC façades and WICLINE window systems.

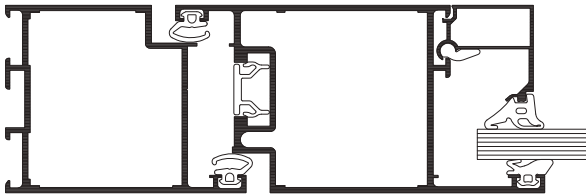

WICSTYLE 50N

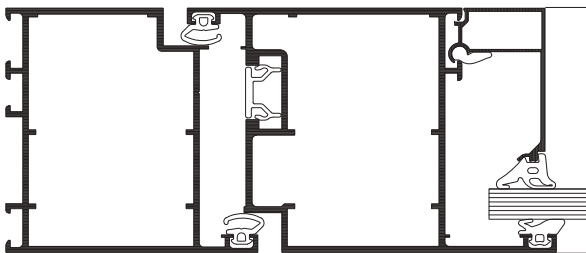

WICSTYLE 65N

Technical capabilities:

Section technology:

- Non-insulated profile with construction depth of 50 mm for WICSTYLE 50N or 65 mm with WICSTYLE 65N
- Single- and double-leaf single-action door with flush-mounted leaves
- Inward- and outward-opening options available
- Fixed or movable side panels and fanlights available
- Glass separators or adhesive glazing bars available
- With rolled strips or screw-on strips
- Mechanical base seal or sill seal

Especially for WICSTYLE 50N:

- Infill thickness: from 4 mm to 31 mm
- Leaf weight: up to 150 kg
- Leaf formats (W x H): up to 1,300 mm x 2,350 mm

Especially for WICSTYLE 65N:

- Infill thickness: from 4 mm to 46 mm (flush-mounted), or from 8 mm to 57 mm (with rollover)
- Leaf weight: up to 200 kg
- Leaf formats (W x H): up to 1,450 mm x 2,700 mm

Additional versions:

- WICSTYLE 65N can also be designed as a smoke protection door, in burglar-resistant Class RC1N to RC2 and as emergency exit/panic door



» Swing doors

WICSTYLE aluminium swing doors can be made inward- or outward opening and aligned according to the user's direction of movement. They are ideally suited to high-traffic areas.

The swing door versions are based on the same technical concept as the WICSTYLE single-action door and offer identical benefits.

WICSTYLE swing doors permit configurations for all conceivable areas of application. They are modular in their design and satisfy the most diverse aesthetic and functional requirements.

As with all WICONA doors, WICSTYLE swing doors can be individually designed and equipped as required. Depending on the client's wishes and style of building, single or double-leaf



versions can be used, and additional features such as finger protection can be easily integrated. WICSTYLE swing doors are compatible with WICTEC façades and WICLINE window systems.



» Swing doors WICSTYLE 65

The swing door variant is based on the same technical concept as the WICSTYLE 65 aluminium door and is available with a 65 mm profile depth. Thanks to WICONA's Unisys principle and the easy integration into WICONA's façade and window systems, a coherent appearance can be achieved across the entire building.

This durable version has successfully undergone durability tests with 1,000,000 opening and closing cycles.



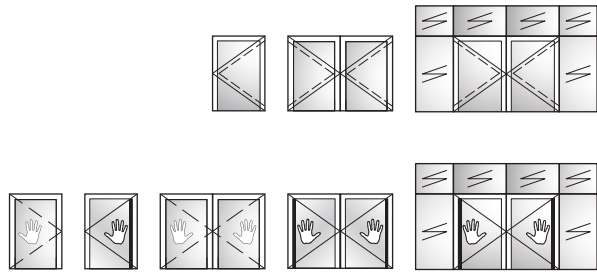

Integration in windows and façades



The WICSTYLE 65 evo range offers two profile versions for single- and double-leaf doors with swing door fittings, which can be combined accordingly with the WICSTYLE basic range.

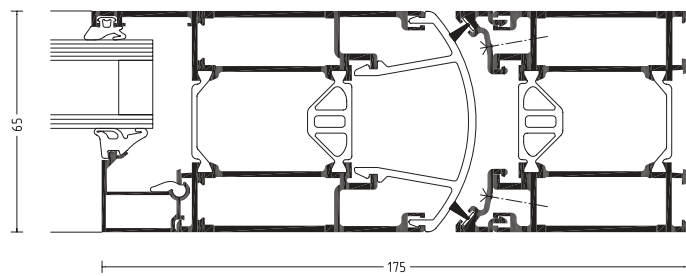

WICSTYLE 65 – Swing door version

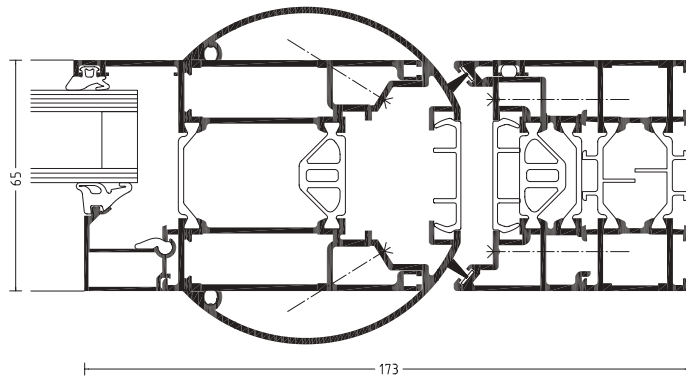

WICSTYLE 65 – Finger protection version

Technical capabilities

Section technology:

- Highly thermally insulated multi-chamber system with symmetrical structure, quality-assured in the factory
- For single-leaf and double-leaf swing doors
- For glass or panels with infill thickness from 3mm to 50 mm
- Different threshold profiles, including accessible
- Fixed, or combined with WICLINE evo windows for opening fanlights and side panels

Fittings:

- With integrated overhead door closure
- With floor-level closure
- Leaf formats (W x H): up to 1,300 mm x 2,300 mm
- Leaf weight: up to 160 kg

Additional versions:

- Integration frame for mullion/transom façades

Test results for product standard DIN EN 14351-1

Air permeability:	Class 2
Ability to withstand wind load:	C1/B1
Continuous operation:	Class 8 1,000,000 cycles
Operating forces:	Class 2



» Security doors

WICONA security doors – perfect functionality without compromise. Burglar and bullet resistance, fire and smoke protection, doors in escape and rescue routes – WICONA brand aluminium profile systems are precisely tailored to legal requirements and comply with all applicable standards. The combination of constructive solutions with the highest

product quality and intelligent innovation promises the best possible customer benefit with the highest levels of security.

The modular construction of the WICSTYLE door range also offers tailor-made configurations in the field of security technology, for every construction situation and every level



of aspiration. The burglar- and bullet-resistant versions, fire protection and finger protection doors, versions with panic function and other additional technical security features can be easily combined with WICTEC façades and WICLINE window systems.



» Burglar-resistant variant WICSTYLE 65 evo / 75 evo

Irrespective of the type of building, windows – and especially doors – count among burglars' preferred targets for attack.

Permanent, effective protection against burglary can be achieved by using an intelligent combination of profile technology, glazing and locking mechanisms.

Protection against burglary is a high priority for all property owners and building operators and is therefore a key aspect of WICONA's professional door solutions.

Thanks to their flexible security features and their classification in various burglar protection classes, WICSTYLE evo aluminium doors can be adapted to suit any required degree of protection – without any visual differences.

The doors are available as 65 mm and 75 mm profiles for all types of configuration, and with dimensions and insulation values to suit the requirements of any building.





Depending on the built-in elements, WICSTYLE evo doors meet the requirements of burglar protection classes RC1 to RC3.

Thanks to the concept of compatibility for all elements, the relevant manufacturing steps are easy to carry out. For the burglar protection version of a WICSTYLE evo standard door, special polyamide profiles were expanded, which prevent objects such as, for example, crowbars being levered into the door, thus acting as a deterrent to burglars.

Multipoint locks and suitable burglar-resistant glazing complete the security features.

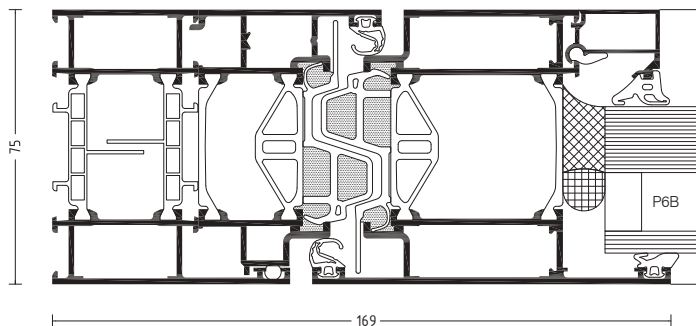

WICTYLE 75 evo – RC2 version

Test results for product standard DIN EN 14351-1

You can find the relevant information on the classifications of each WICSTYLE evo range.

Requirements for emergency exits for WICSTYLE 65 evo / 75 evo doors

When developed for escape routes and emergency exits, WICSTYLE 65 evo / 75 evo doors meet the following standards:

- EN 179: Locks and fittings – emergency exit closures with pusher or push plate for doors on escape routes
- EN 1125: Locks and fittings – panic door closures with horizontal operating bar for doors on rescue routes

WICONA solutions include pushers with bars integrated into the leaf, surface-mounted bars or bumpers for all areas of application in private and public buildings such as schools, hospitals and shopping centres.

WICSTYLE 65 evo / 75 evo door systems can also be combined with other functions and design options.

Technical capabilities

Burglar resistance in accordance with EN 1627 Standard:

- In European countries the EN 1627 burglar protection standard, which replaces the previous national standards, now applies. The classifications were replaced by Classes RC1N to RC3, which do not correspond with the previous Classes WK1 to WK3.

Test results for the WICONA range of doors:

- The new WICSTYLE 65 evo and WICSTYLE 75 evo range of doors was subjected to tests in accordance with the new EN 1627 Standard. They can be easily labelled and used in accordance with this standard without any further measures.

Burglar resistance in accordance with EN 1627 Standard/Classes:

- WICSTYLE 65 evo RC1N, RC2N, RC2, RC3
- WICSTYLE 75 evo RC1N, RC2N, RC2, RC3

Burglar-resistant doors in escape and rescue routes:

- Burglar-resistant doors up to Class RC3 can be combined with escape route door fittings in accordance with the EN 179 or EN1125 standards.



» Bullet-resistant variant WICSTYLE 65 evo / 75 evo

Façades, windows and doors must offer protection against firearms in high-risk buildings such as banks, government agencies, embassies or police stations.

To comply with the requirements of these particular types of application, WICONA can offer a range of bullet-resistant products for a complete, unified solution. This protective function for each structure is highly effective, without affecting the appearance of the building.

The bullet-resistant versions of the WICSTYLE evo aluminium doors are available as 65 mm and 75 mm profiles for all configurations in the range.

The scope of performance for each door construction is dependent on the requirements of the building.





Following the WICONA Unisys principle, the bullet-resistant version of the WICSTYLE aluminium doors was developed from the the WICSTYLE evo range.

The design construction of the WICSTYLE evo standard door is expanded using surface-mounted aluminium profiles to offer protection against firearms. The appearance of the doors fronts which are protected in this way remain visually unchanged compared with standard version.

There is no change to the manufacturing process either, so no additional time is required.

Naturally, the door must be supplemented with multipoint locks and suitable bullet-resistant glazing.

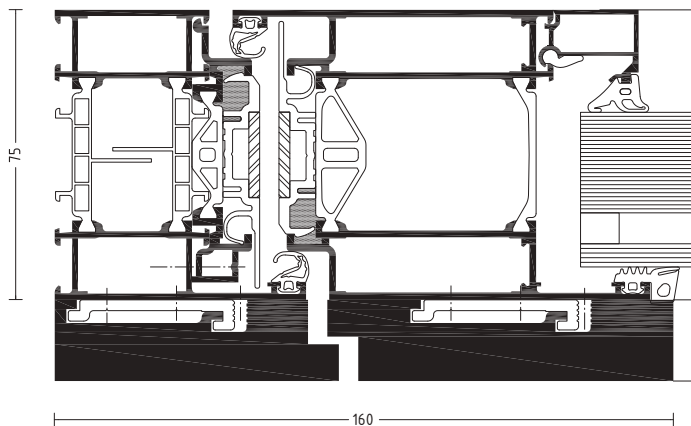

WICSTYLE 75 evo – Bullet-resistant version

Test results for product standard DIN EN 14351-1

You can find the relevant information on the classifications of each WICSTYLE evo range.



Technical capabilities

Bullet-resistance in accordance with the EN 1522 Standard:

- Bullet-resistance requirements for doors are regulated across Europe by the EN 1522 Standard. The new WICSTYLE 65 evo and WICSTYLE 75 evo door ranges were tested to this standard in various profile combinations and meet FB4 S and FB4 NS standards.
- The bullet-resistant version can be combined with the burglar-resistant versions of Classes RC1N, RC2N, RC2 and RC3 in accordance with EN 1627.

Possible combinations with other WICONA product ranges for bullet-resistance Class FB4:

- Windows WICLINE 65/75 evo
- Façades WICTEC 50

Bullet-resistance in accordance with the EN 1522 Standard, Classifications:

- WICSTYLE 65/75 evo single-action door, single- or double-leaf, inward or outward opening FB4 S/FB4 NS



» Fire protection doors WICSTYLE 77 FP Fire protection variant

Fire protection is among the most demanding challenges in the area of security technology for buildings. The WICSTYLE 77FP fire protection door offers suitable solutions in the required flame-retardancy and fire protection classes for public building, hospitals, hotels, healthcare facilities, schools, and event and leisure facilities. This applies to new-builds as well as to modernisation projects.

With the WICSTYLE 77FP fire protection and firewall ranges, WICONA proves that effective fire protection and harmonious aesthetics are not mutually exclusive.

The ranges can be used in combination with WICTEC 50 FP façades and with WICLINE 75 FP windows.



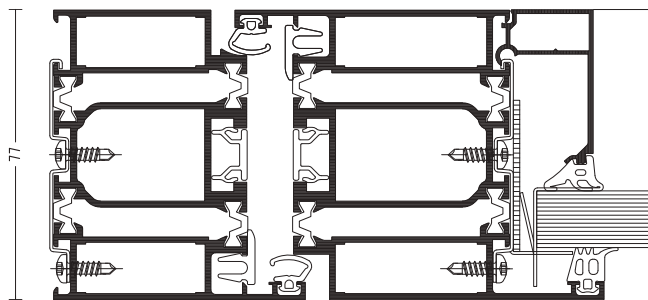

WICSTYLE 77FP

Technical capabilities

Section technology:

- Approved by building authorities
- Tested in accordance with DIN 4102 and DIN EN 13501-2 Standards
- Version in the fire protection classes EI30 / T30 without fire protection panels
- Mesh doors in the fire protection classes EI60 / T60 by simply inserting fire protection strips
- Single-leaf and double-leaf version, opening inwards and outwards available.
- Fixed glazing, fanlights and side panels available in many versions.
- Identical profile view as the WICSTYLE 65 evo and WICSTYLE 75 evo ranges
- Burglar resistance Classes RC1N to RC2

Fittings:

- Screw-on and rolled strips in aluminium or stainless steel, in the same design as the WICSTYLE basic series, which enables fine-tuned building design.
- Comprehensive fittings technology for requirements such as panic function, fire door locks, electrical security locks, electric openers, rotary door closer, magnetic contact and bar contact
- Authorised for large-format applications:
- Small passage size: 1,462 mm x 2,990 mm (single-leaf); 2,943 mm x 2,990 mm (double-leaf)
- Leaf weight: up to 260 kg

Firewall:



» Smoke protection doors / Fireproof partition walls EW 30 WICSTYLE 65N

These types of construction are specifically designed for applications inside buildings or for when there are no requirements for thermal insulation. When it is a priority of effective smoke protection, these non-insulated doors are the right choice.

They are fully compatible with the WICTEC and WICLINE product ranges.



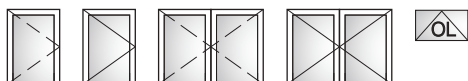

Integration in windows and façades

WICSTYLE 65N RS Smoke protection doors

The WICSTYLE 65N RS is an aluminium smoke protection door with the same sight profile as the standard and thermally insulated WICONA door ranges.

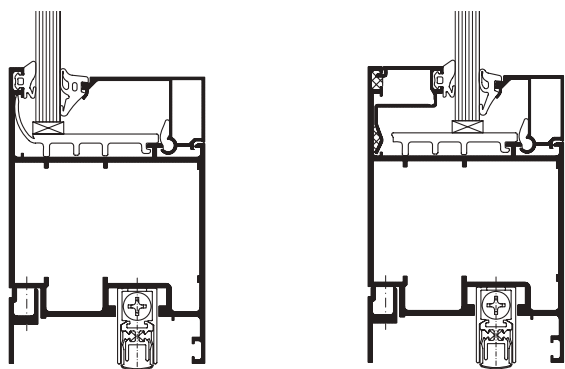

Test results for product standard NF EN 14351-1

Air permeability:	Class 2 (A*2)
Ability to withstand wind load:	C1/B1 (V*C1/B1)
Continuous operation:	Class 8 1,000,000 cycles
Load capacity of safety devices:	passed
Operating forces:	Class 2

The stipulations of the national permit are to be followed

WICSTYLE 65N Fireproof partition walls EW 30

These types of construction are specifically designed for applications inside buildings or for when there are no requirements for thermal insulation. When factors such as internal security come into focus, these non-insulated fireproof partition walls are the right choice.

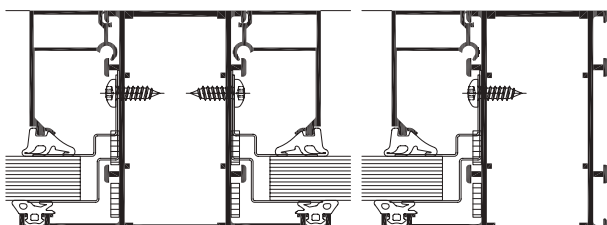

The stipulations of the national permit are to be followed



Technical capabilities

Section technology:

- Non-insulated profile with a construction depth of 65 mm
- Single- and double-leaf single-action door with flush-mounted leaves
- Inward- and outward-opening options available
- Fixed or movable side panels and fanlights available
- Glass separators or adhesive glazing bars available
- With rolled strips or screw-on strips
- Mechanical base seal or sill seal

Especially for WICSTYLE 65N:

- Infill thickness: 4 mm to 46 mm (flush-mounted), or 8 mm to 57 mm (with rollover)
- Leaf weight: up to 200 kg
- Leaf formats (W x H): up to 1,450 mm x 2,700 mm

Additional versions:

- WICSTYLE 65N Burglar-resistance Classes RC1N to RC2

Technical capabilities

- Non-insulated profile with a construction depth of 65 mm
- Tested according to DIN EN 1364
- Version in the fire protection Class EW 30 with the simple addition of accessories
- Same appearance as standard WICSTYLE 65N range
- Glass separators or adhesive glazing bars available
- Infill thickness: 13 mm, 20 mm up to 24 mm
- Max. height 3,500 mm
- No length limit

» Automatic doors

Automatic doors offer maximum convenience for high-traffic entrance areas. With the WICSLIDE 65ED, WICONA offers a safe and efficient solution for these areas of application, with leaf dimensions up to 3,000 mm.





» Thermally insulated automatic sliding door WICSTYLE 65ED

WICSTYLE 65ED, the energy-saving automatic sliding door for public areas, was developed together with the Swiss global market leader Gilgen Door Systems, based on the profile of the WICLINE 65. Automatic sliding doors have short opening and closing cycles, to allow optimum transit through them. They therefore keep most of the heat in the building during operation. But also important for energy efficiency are the times when the door stays permanently closed – for example, at night.

WICSTYLE 65ED reliably protects the building against high energy loss precisely at such times, and thus significantly contributes to improving the overall energy balance of the building.



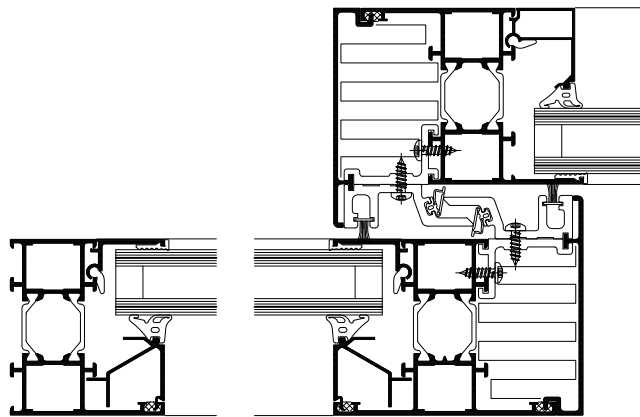

WICSTYLE 65ED

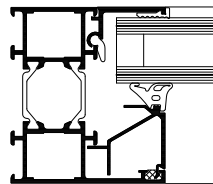

Technical capabilities

Section technology:

- Security tested in accordance with the personal protection requirements of DIN 18650
- Tested complete system (thermally separated profile system and drive unit) in accordance with DIN EN 14351-1
- Landmark thermal insulation with U_d -Values below $1.5 \text{ W/(m}^2\text{K)}$
- Up to 70% less energy loss when closed
- Thicker than normal doors due to circumferential double seals and labyrinth, with values to those of a domestic front door!
- Reliable door automation by Gilgen Door Systems
- Ideal for retrofitted installations
- Attractive appearance due to narrow sight lines
- Infill thickness from 24 mm to 27 mm
- Single- or double-leaf versions, with or without side panels, as well as a variety of options for fittings and closures such as multipoint locks for increased burglar-resistance

Thermal insulation:

- U_d -Values: up to $1.5 \text{ W/(m}^2\text{K)}$

Drive system/ Fittings:

- Single-leaf or double-leaf door systems
- Drive systems SLA, SLX or SLX redundant
- Can be used for escape routes and rescue routes
- Leaf weight: up to 150 kg
- Leaf formats (W x H): up to 2,000 mm x 3,000 mm

System tests / CE product pass to DIN EN 14351-1

Air permeability:	Class 2
Driving rain resistance:	5A
Ability to withstand wind load:	Class B1
Quality management:	Certified to ISO 9001:2008
Environmental management:	Certified to ISO 14001



Austria

5201 Seekirchen
☎ +43 6212 2000
✉ info@wicona.at

Benelux

3400 Landen
☎ +32 11 690316
✉ info@wicona.be
✉ info@wicona.nl

Croatia

43000 Bjelovar
☎ +385 43 22 25 46
✉ info@wicona.de

Czech Republic

619 00 Brno
☎ +420 602 745 407
✉ wicona@wicona.cz

Denmark

8240 Risskov
☎ +45 7020 2048
✉ wicona@wicona.dk

España

08195 Sant Cugat del Vallès
Barcelona
☎ +34 93 573 77 76
✉ wicona.es@wicona.com

Estonia / Latvia

75312 Rae vald Harjumaa
☎ +372 657 66 35
✉ info@wicona.ee

France

02200 Courmelles
☎ +33 3 23598200
✉ info@wicona.fr

Germany

89077 Ulm
☎ +49 731 3984-0
✉ info@wicona.de

Hungary

1031 Budapest
☎ +36 (1) 4533457
✉ info@wicona.hu

Ireland

Dublin 22
☎ +353 1 4105766
✉ info@wicona.ie

Italia

20063 Cernusco sul Naviglio MI
☎ +39 02 924291
✉ info@wicona.it

Lithuania / Latvia

02244 Vilnius
☎ +370 5 2102587
✉ info@wicona.lt

Norway

2007 Kjeller
☎ +47 22 42 22 00
✉ wicona@wicona.no

Poland

93-428 Łódź
☎ +48 42 683 63 73
✉ info@wicona.pl

Romania

031041 Bucharest
☎ +40 21 3260045
✉ info@wicona.de

Serbia

11070 Beograd
☎ +381 11 312 18 35
✉ info@wicona.de

Slovakia

82105 Bratislava
☎ +421 918 725 098
✉ info@wicona.sk

Slovenia

2201 Zg. Kungota
☎ +386 26 20 99 70
✉ info@wicona.de

Sweden

574 81 Vetlanda
☎ +46 470 78 74 00
✉ wicona@wicona.se

Switzerland

5506 Mägenwil
☎ +41 62 88741-41
✉ info@wicona.ch

United Kingdom

Wakefield WF5 9TG
☎ +44 1924 232323
✉ info.wiconauk@wicona.com

China

Beijing 100005, P.R.C
☎ +86 10 6059 5686 ext. 805
✉ contact.wicona.international@wicona.com

Singapore

608831 Singapore
☎ +65 6513 2126
✉ contact.wicona.international@wicona.com

United Arab Emirates

Dubai
☎ +971 4 887 00 96
✉ contact.wicona.international@wicona.com

Other countries

31037 Toulouse
☎ +33 5 61312626
✉ contact.wicona.international@wicona.com